

A1 B1

A2 B2

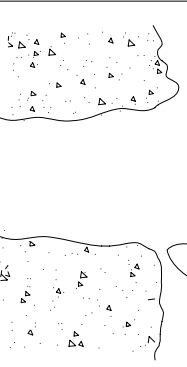

1). Setzen Sie die Leuchte erst in ein ca. 15cm hohes Sandbett ein.
2). Füllen Sie danach das restlich ausgehobene Loch mit beton aus.

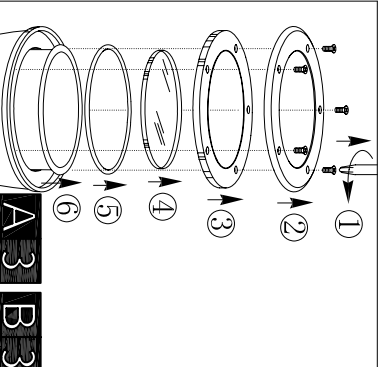

A3 B3

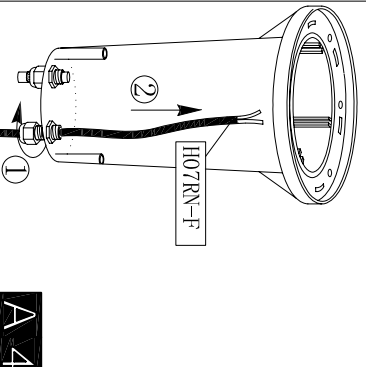

A4

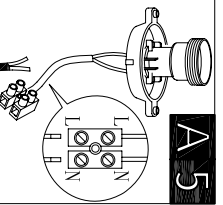

A5

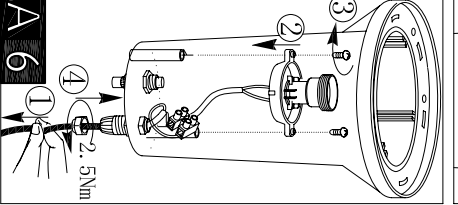
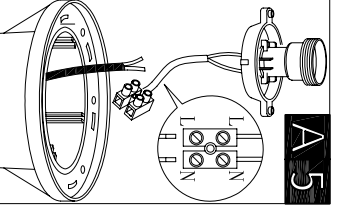

A6

A7

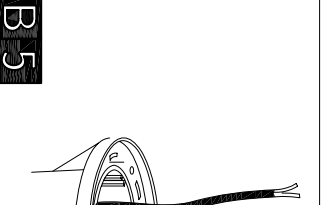
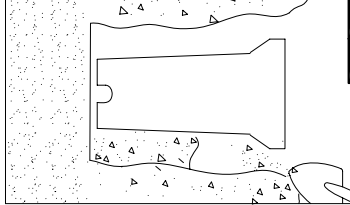

B5

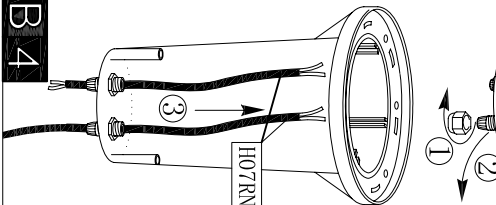
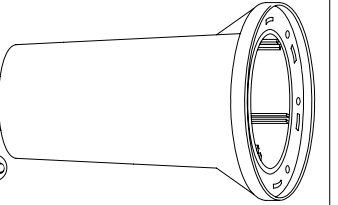

B4

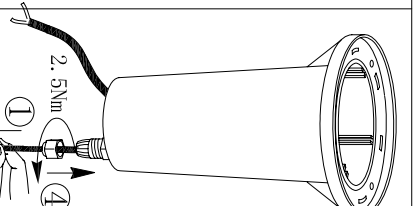
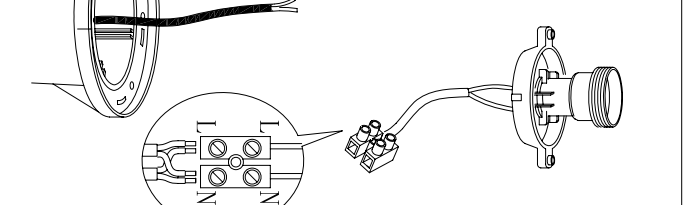

B6

B7

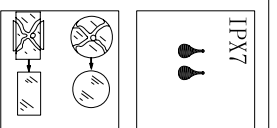
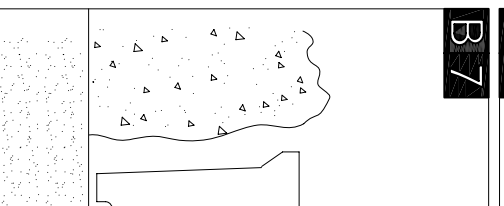
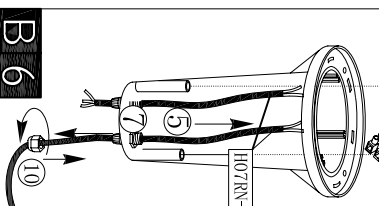
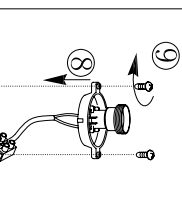

A

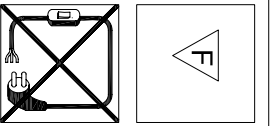

B

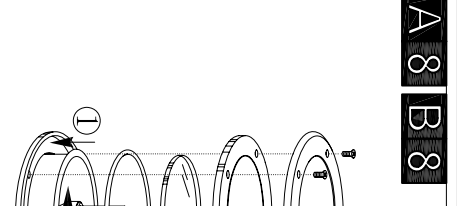
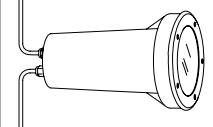
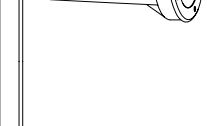
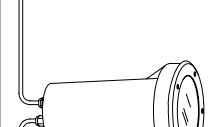
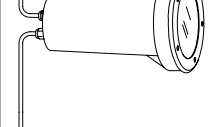
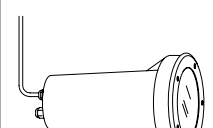
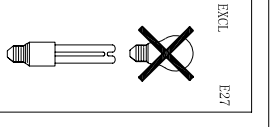
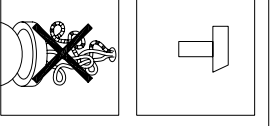
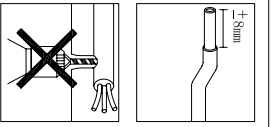
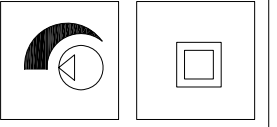

A8 B8

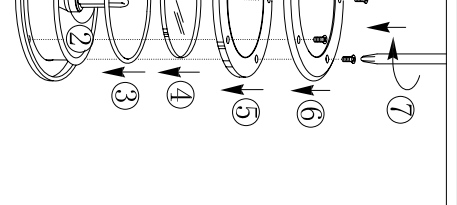

A9 B9

BLA86189-2